

MAXIMUM PCB SIZE (1 : 2)

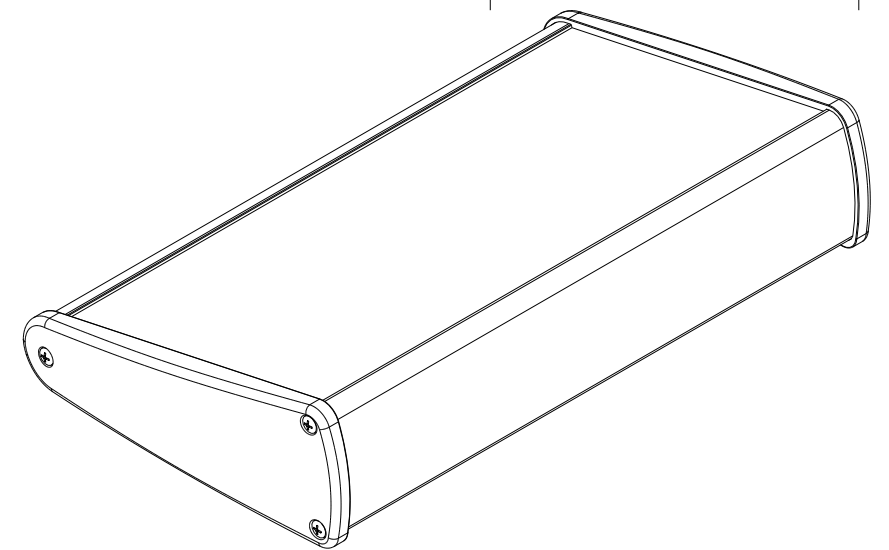

Right panel

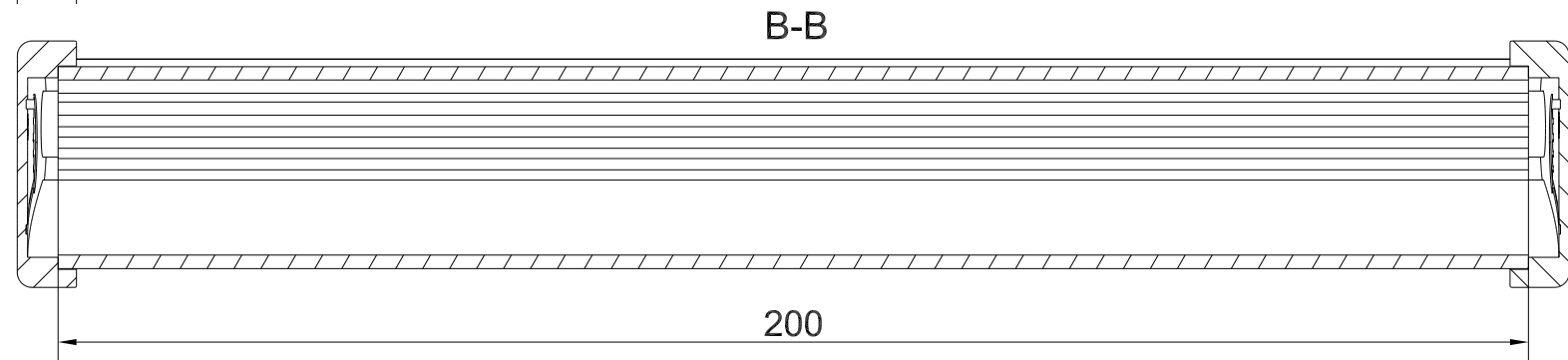
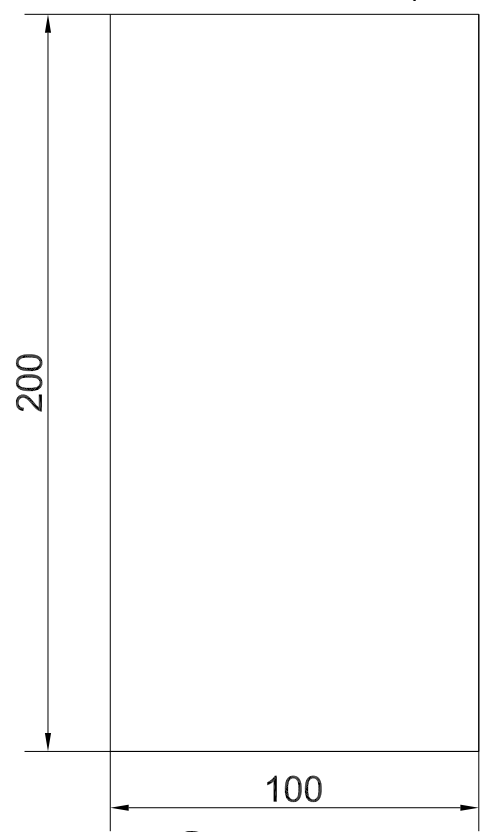
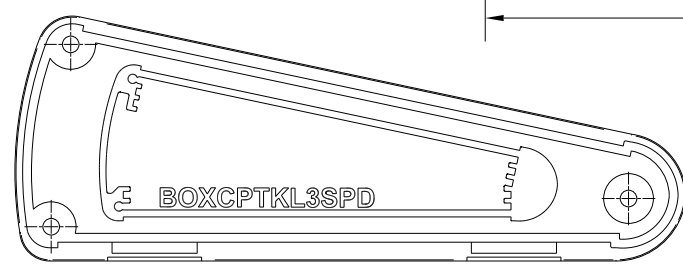

Left panel

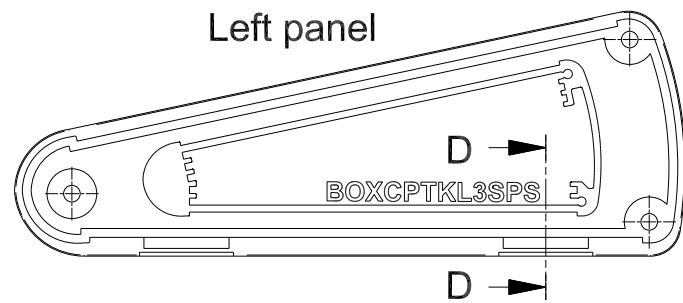

D-D (2 : 1)

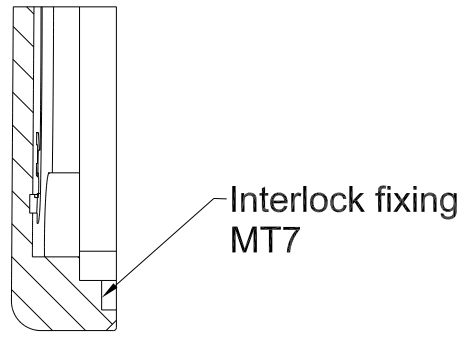

	Denomination	Part. Number	
	Assembly TEKAL-33SP	TEKAL-33SP	
	Subject to technical modification without prior notice. Tipographical and other errors do not justify any claim for damages. All dimensions should be verified using an actual moulded part.	Rev. Index	Scale
	This document contains proprietary information of TEKO S.p.a. and is tendered subject to the conditions that the information be retained in confidence not be reproduced or copied and not be used or incorporated in any product.		1:1
		Date	Format design
		01/10/2008	A3