

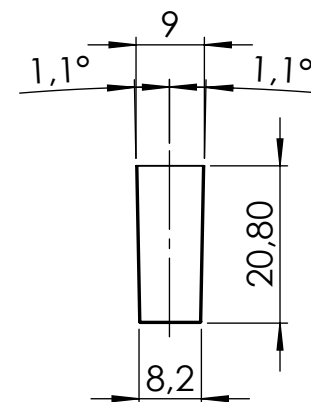

SEZIONE A-A

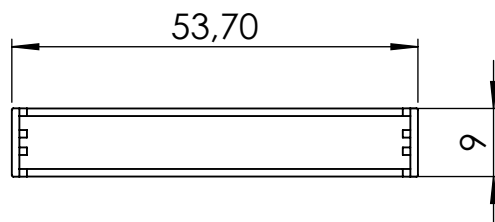
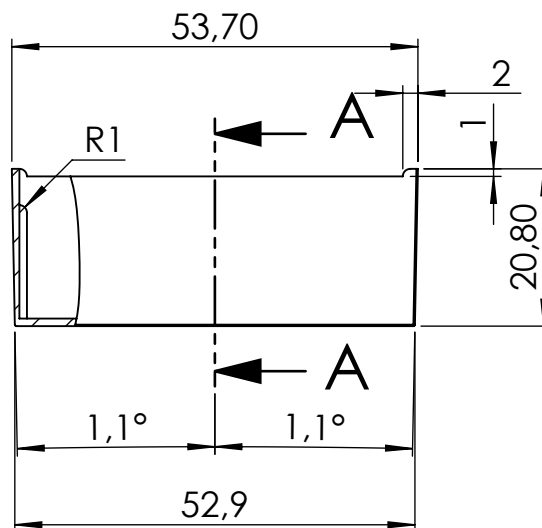
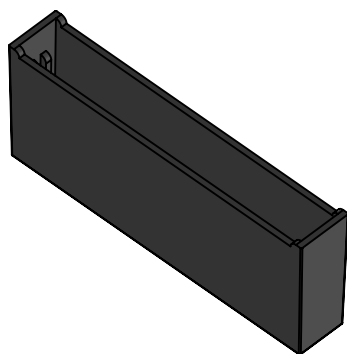
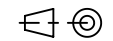

Proprietary and Confidential	TEKO S.p.A. Via dell'Industria 5 - S.Lazzaro di Savena - BO - IT			
	<i>Subject to technical modification without prior notice. Tipographical and others errors do not justify any claim for damages. All dimensions should be verified using an actual moulded part.</i>			
	Part Number: S10	Date: 02/01/2023	Sheet: 1 of 1	First angle prj. 
<small>This document contains proprietary information of TEKOS.p.a. and is tendered subject to the conditions that the information be retained in confidence not be reproduced or copied and not be used or incorporated in any product</small>			Size: A4	Scale: 1:1